

# NIBCO®

AHEAD OF THE FLOW®



CPVC BlazeMaster®  
Fire Protection Fittings

# Business-to-Business Solutions

Look to NIBCO for technology leadership.

The velocity with which e-business evolves demands that new products and services be continuously developed and introduced to keep our customers at the center of our business efforts. NIBCO provides an entire suite of business-to-business solutions that is changing the way we interact with customers.



[NIBCOpartner.com<sup>SM</sup>](#) is an exclusive set of secure web applications that allow quick access to customer-specific information and online order processing. This self-service approach gives you 24/7 access to your order status putting you in total control of your business.

Real time information includes:

- Online order entry
- Viewable invoices & reports
- Inventory availability
- Current price checks
- Order status
- Online library of price sheets, catalogs & submittals



**Electronic Data Interchange (EDI)** makes it possible to trade business documents at the speed of light. This technology cuts the cost of each transaction by eliminating the manual labor and paperwork involved in traditional order taking. This amounts to cost-savings, increased accuracy and better use of resources.

With EDI, you can trade:

- Purchase orders
- PO Acknowledgements
- Invoices
- Product activity data
- Advanced ship notices
- Remittance advice



**Vendor Managed Inventory (VMI)**, a sophisticated service for automated inventory management, reduces your overhead by transferring inventory management, order entry and forecasting to NIBCO. This is an on-going, interactive partnership with NIBCO.

Through automation, VMI brings results:

- Improves customer service
- Optimum inventory efficiencies
- Better forecasting
- Cuts transaction costs
- Peace of mind
- Relief from day-to-day management

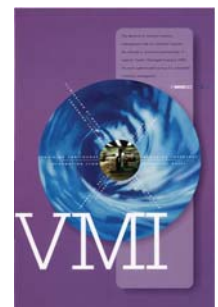



*Visit our website for the most current information .*

## Table Of Contents

Numerical Index .....	4
Key to NIBCO Figure Numbers.....	5
Specifications and Engineering Data.....	6
CPVC Standard Fire Protection Fittings .....	7-13
CPVC Threaded Fire Protection Fittings.....	14-19
IPS to CTS Transition Fittings.....	19
Cement and Accessories.....	20-21
Typical Residential Riser.....	22
Valves for Residential Fire Protection.....	23
Do's and Don'ts .....	24
CPVC Cross Reference Sheet.....	25-26
Warranty.....	30

**BlazeMaster**<sup>®</sup>  
FIRE SPRINKLER FITTINGS

BlazeMaster<sup>®</sup> is a registered trademark of The Lubrizol Corporation.

# Numerical Index

## CPVC BlazeMaster® Fire Protection Fittings

CPVC FIG NO	PAGE
5001-G	8
5001	9
5001-R	9
5003-BI	15
5003-2-BI	15
5003-S-BI	16
5003-2-S-BI	16
5003-S-BT	16
5004-BI	15
5003-BI-BSP	15
5006	10
5007	10
5007-R	10
5007-3-S-BI	17
5011	12
5011-R	12
5011-3-3-S-BI-L	18
5011-3-3-S-BI-S	18
5012-S-BI	18
5012-R-S-BI	18
5014-R-S-BI	18
5017	9

CPVC FIG NO	PAGE
5018	8
5019-H	11
5051-H	11
5033-E	13
5035	9
5035-R	9
5035-3-S-BI-L	17
5035-3-S-BI-S	17
450-005	19
4701-T	19
4718-T	19
5097-Q	20
5097-P	20
5098-Q	20
5098-P	20
5098-G	20
5096	20
5097	20
5093-S	20
5093-L	20
5094	21
5099	21

BlazeMaster® is a registered trademark of The Lubrizol Corporation.

**BlazeMaster®**  
FIRE SPRINKLER FITTINGS

# Key to NIBCO Figure Numbers

## TYPE OF MATERIAL

50 = CPVC Fire Protection

## TYPE OF FITTING & DESCRIPTION

01 = Coupling  
03 = Female Adapter  
04 = Male Adapter  
06 = 45° Elbow  
07 = 90° Elbow  
11 = Tee  
12 = Sprinkler Head Tee (Thread on Outlet)  
14 = Sprinkler Head Tee (Thread on Run)  
17 = Cap  
18 = Bushing  
19 = Blind Flange  
33 = Unions  
35 = Cross  
51 = Solid Flange

## TYPE OF CONNECTIONS

2 = Fitting Connection Spigot  
3 = Female NPT Thread Connection  
4 = Male NPT Thread Connection  
S = Sprinkler Head Adapter  
BI = Brass Insert  
BT = BRASTIC®  
R = Reducing

## Fitting Terms and Abbreviations

FNPT = Female NPT Thread  
MNPT = Male NPT Thread  
S or SLIP = Female Socket  
SPG = Male End (Spigot)  
G = Grooved  
L = Large  
S = Small  
H = Heavy  
IPS = Iron Pipe Size  
CTS = Copper Tube Size  
Q = Quart  
P = Pint

**BlazeMaster**®  
FIRE SPRINKLER FITTINGS

BlazeMaster® is a registered trademark of The Lubrizol Corporation.

# Specifications and Engineering Data

## Introduction

NIBCO® **BlazeMaster®** CPVC Fire Sprinkler products produced by NIBCO are manufactured from high quality, Post-Chlorinated Polyvinyl Chloride (CPVC), a specialty thermoplastic material tested and listed by certifying agencies for use in CPVC fire sprinkler systems. NIBCO CPVC Fire Sprinkler products provide unique advantages over traditional metal fire sprinkler systems through superior hydraulics, ease of installation and handling and quick assembly using readily available, inexpensive tools. These products also are based on a technology with a continuous and proven service history of more than forty (40) years.

## Pressure Rating

NIBCO **BlazeMaster®** CPVC Fittings of nominal sizes 3/4" – 3" (20 – 80 mm) are rated for continuous service of 175 psi (1270 kPa) at 150°F (65°C).

## Approvals

NIBCO **BlazeMaster®** CPVC fittings for fire sprinkler systems meet the approval and listing requirements of NFPA 13, 13D, and 13R.

NIBCO **BlazeMaster®** CPVC Fittings are listed by NSF to ANSI / NSF Standard 61 for health effects and may be used in potable water applications.

NIBCO **BlazeMaster®** CPVC Fittings carry the markings of Factory Mutual (FM) and Underwriters Laboratories Inc. (C-UL-US) for listings in the United States and Canada.

NIBCO **BlazeMaster®** CPVC 3/4" to 3" Fittings are listed by the Loss Prevention Safety Board (LPCB).

NIBCO **BlazeMaster®** CPVC Fittings are accepted for use by the City of New York Department of Buildings MEA 280-07-E.

## Use with other Manufacturers' Pipes, Fittings, & Solvent Cements

NIBCO **BlazeMaster®** CPVC Fire Sprinkler products are listed by UL standard 1821 & C-UL standard UCC/ORD-C199P and FM standard 1635. These listings require rigorous testing to ensure the products will function as a component of the assembled fire protection system. For Fire Protection CPVC pipe the current UL standard is 1821 & C-UL standard UCC/ORD-C199P and FM standard 1635. NIBCO warrants our fittings with all CPVC pipe and fittings that are in compliance with the same listings by UL & FM. A current list of compatible UL and C-UL Listed CPVC manufacturers are: Viking (pipe), Harvel (pipe), TYCO Fire Products (pipe & fittings), IPEX (pipe & fittings) and Spears (pipe & fittings).

NOTICE: While NIBCO **BlazeMaster®** CPVC Fire Sprinkler Products are UL Listed for use in combination with other listed manufacturers' products, specific application approvals may not be the same among manufacturers. It is the installer's responsibility to verify suitability of products used in combination according to each manufacturer's installation instructions. Contact NIBCO if you have questions on any application not addressed in this manual.

## Engineering Data – Product Specifications

NIBCO **BlazeMaster®** CPVC Fire Sprinkler Products are made for use with Listed CPVC Fire Sprinkler Pipe Produced in SDR 13.5 dimensions, as specified in ASTM F 442.

NIBCO **BlazeMaster®** CPVC Fire Sprinkler Fittings are produced in Schedule 40 dimensions for sizes 3/4 inch (20 mm) through 1-1/4 inch (32 mm) in accordance with ASTM F 438 and Schedule 80 dimensions for sizes 1-1/2 inch (40 mm) through 3 inch (80 mm) in accordance with ASTM F 439. These products are UL and C-UL Listed, and FM Approved for a rated working pressure of 175 psi (1200 kPa) at 150°F (65°C) for sprinkler service.

## Installation Instructions

For complete installation instructions see NIBCO's "Installation and Design Manual."



BlazeMaster® is a registered trademark of The Lubrizol Corporation.

**BlazeMaster®**  
FIRE SPRINKLER FITTINGS

## CPVC Standard Fire Protection Fittings

Grooved Adapters .....	8
Bushings .....	8
Caps .....	9
Couplings .....	9
Crosses .....	9
Elbows .....	10
Flanges .....	11
Tees .....	12
Unions.....	13

BlazeMaster<sup>®</sup> is a registered trademark of The Lubrizol Corporation.

**BlazeMaster<sup>®</sup>**  
FIRE SPRINKLER FITTINGS

# BlazeMaster® Fire Protection Fittings – STANDARD

## ADAPTERS

### 5001-G

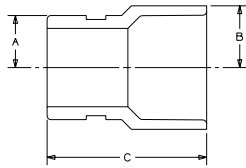

### Grooved Coupling Adapters (G x S)

UNIV. FIG. NO.	NOM. SIZE	APPROX. NET WT./LBS.	DIM. A INCHES	DIM. B INCHES	DIM. C INCHES	JOINT
5001-G	1-1/4"	0.17	0.83	1.04	2.98	GXS
5001-G	1-1/2"	0.20	0.95	1.17	3.15	GXS
5001-G	2"	0.30	1.18	1.43	3.37	GXS
5001-G	2-1/2"	0.52	1.43	1.74	3.66	GXS
5001-G	3"	0.72	3.50	—	—	GXS

## BUSHINGS

### 5018

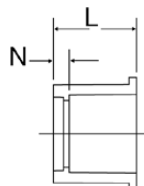

### Bushings

UNIV. FIG. NO.	NOM. SIZE	APPROX. NET WT./LBS.	DIM. L INCHES	DIM. N INCHES	JOINT
5018	1"x3/4"	0.04	1.28	0.29	SPGXS
5018	1-1/4"x1"	0.08	1.41	0.29	SPGXS
5018	1-1/4"x3/4"	0.10	1.41	0.41	SPGXS
5018	1-1/2"x1-1/4"	0.07	1.54	0.27	SPGXS
5018	1-1/2"x1"	0.12	1.54	0.39	SPGXS
5018	1-1/2"x3/4"	0.16	1.54	0.53	SPGXS
5018	2"x1-1/2"	0.16	1.66	0.27	SPGXS
5018	2"x1-1/4"	0.20	1.66	0.40	SPGXS
5018	2"x1"	0.22	1.66	0.52	SPGXS
5018	2"x3/4"	0.22	1.66	0.64	SPGXS
5018	2-1/2"x2"	0.24	1.94	0.44	SPGXS
5018	2-1/2"x1-1/2"	0.36	1.94	0.57	SPGXS
5018	2-1/2"x1-1/4"	0.37	1.94	0.68	SPGXS
5018	2-1/2"x1"	0.36	1.94	0.81	SPGXS
5018	3"x2-1/2"	0.47	2.42	0.60	SPGXS
5018	3"x2"	0.66	2.42	0.93	SPGXS
5018	3"x1-1/2"	0.73	2.42	1.03	SPGXS



# BlazeMaster® Fire Protection Fittings – STANDARD

## CAPS

5017

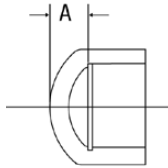

### Caps

UNIV. FIG. NO.	NOM. SIZE	APPROX. NET WT./LBS.	DIM. A INCHES	JOINT
5017	3/4"	0.04	0.31	S
5017	1"	0.06	0.39	S
5017	1-1/4"	0.22	0.56	S
5017	1-1/2"	0.30	0.68	S
5017	2"	0.42	0.68	S
5017	2-1/2"	0.62	1.20	S
5017	3"	0.96	1.26	S

## COUPLINGS

5001  
5001-R

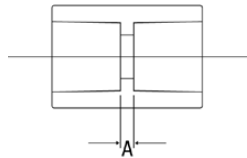

### Couplings

UNIV. FIG. NO.	NOM. SIZE	APPROX. NET WT./LBS.	DIM. A INCHES	JOINT
5001	3/4"	0.06	0.12	SXS
5001	1"	0.08	0.09	SXS
5001	1-1/4"	0.12	0.08	SXS
5001	1-1/2"	0.30	0.27	SXS
5001	2"	0.44	0.28	SXS
5001	2-1/2"	0.72	0.20	SXS
5001	3"	1.10	0.22	SXS
5001-R	1"x3/4"	0.08	0.29	SXS
5001-R	1-1/4"x1"	0.12	0.35	SXS
5001-R	1-1/2"x1-1/4"	0.38	0.51	SXS
5001-R	1-1/2"x1"	0.36	0.67	SXS
5001-R	1-1/2"x3/4"	0.34	0.80	SXS
5001-R	2"x1-1/2"	0.52	0.51	SXS
5001-R	2"x1"	0.48	0.75	SXS

## CROSSES

5035  
5035-R

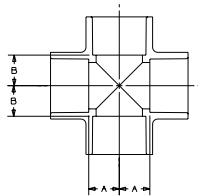

### Crosses

UNIV. FIG. NO.	NOM. SIZE	APPROX. NET WT./LBS.	DIM. A INCHES	DIM. B INCHES	JOINT
5035	3/4"	0.12	0.61	0.61	SXSXSXS
5035	1"	0.24	0.75	0.75	SXSXSXS
5035	1-1/4"	0.34	0.90	0.90	SXSXSXS
5035	1-1/2"	0.69	1.23	1.23	SXSXSXS
5035	2"	1.02	1.53	1.53	SXSXSXS
5035	2-1/2"	1.70	1.75	1.75	SXSXSXS
5035	3"	3.12	1.89	1.89	SXSXSXS
5035-R	1"x1"x3/4"x3/4"	0.18	0.61	0.73	SXSXSXS

**BlazeMaster®**  
FIRE SPRINKLER FITTINGS

BlazeMaster® is a registered trademark of The Lubrizol Corporation.

# BlazeMaster® Fire Protection Fittings – STANDARD

## ELBOWS

### 5006

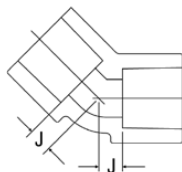

### 45° Elbows

UNIV. FIG. NO.	NOM. SIZE	APPROX. NET WT./LBS.	DIM. J INCHES	JOINT
5006	3/4"	0.06	0.32	SXS
5006	1"	0.12	0.39	SXS
5006	1-1/4"	0.18	0.48	SXS
5006	1-1/2"	0.36	0.47	SXS
5006	2"	0.54	0.58	SXS
5006	2-1/2"	1.00	0.65	SXS
5006	3"	1.28	0.76	SXS

### 5007 5007-R

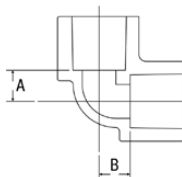

### 90° Elbows

UNIV. FIG. NO.	NOM. SIZE	APPROX. NET WT./LBS.	DIM. A INCHES	DIM. B INCHES	JOINT
5007	3/4"	0.08	0.56	0.56	SXS
5007	1"	0.14	0.69	0.69	SXS
5007	1-1/4"	0.22	0.91	0.91	SXS
5007	1-1/2"	0.41	1.06	1.06	SXS
5007	2"	0.60	1.24	1.24	SXS
5007	2-1/2"	1.16	1.50	1.50	SXS
5007	3"	1.66	1.81	1.81	SXS
5007-R	1"x3/4"	0.12	0.61	0.75	SXS

# BlazeMaster® Fire Protection Fittings – STANDARD

## FLANGES

*Future Offering*

### 5019-H

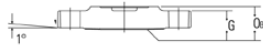

### Blind Flanges – Solid

UNIV. FIG. NO.	NOM. SIZE	APPROX. NET WT./LBS.	DIM. G INCHES	DIM. OB INCHES
5019-H	3/4"	0.32	0.58	0.80
5019-H	1"	0.43	0.64	0.84
5019-H	1-1/4"	0.57	0.69	0.94
5019-H	1-1/2"	0.69	0.78	1.00
5019-H	2"	1.08	0.83	1.13
5019-H	2-1/2"	1.81	0.96	1.22
5019-H	3"	2.45	1.05	1.31

### 5051-H

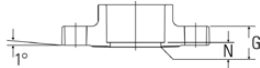

### Flanges – Solid

UNIV. FIG. NO.	NOM. SIZE	APPROX. NET WT./LBS.	DIM. G INCHES	DIM. N INCHES	JOINT
5051-H	3/4"	0.31	0.58	0.17	S
5051-H	1"	0.41	0.64	0.18	S
5051-H	1-1/4"	0.53	0.69	0.20	S
5051-H	1-1/2"	0.68	0.78	0.23	S
5051-H	2"	1.03	0.83	0.27	S
5051-H	2-1/2"	1.61	1.96	0.20	S
5051-H	3"	2.08	1.05	0.29	S

BlazeMaster® is a registered trademark of The Lubrizol Corporation.

**BlazeMaster®**  
FIRE SPRINKLER FITTINGS

# BlazeMaster® Fire Protection Fittings – STANDARD

## TEES

### 5011

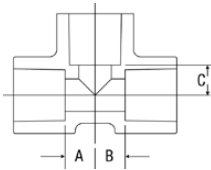

### 5011-R

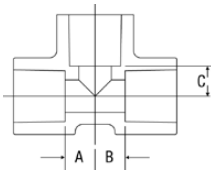

## Tees

UNIV. FIG. NO.	NOM. NOM. SIZE	APPROX. NET WT./LBS.	DIM. A INCHES	DIM. B INCHES	DIM. C INCHES	JOINT
5011	3/4"	0.10	0.57	0.57	0.57	SXSXS
5011	1"	0.17	0.69	0.69	0.69	SXSXS
5011	1-1/4"	0.28	0.89	0.89	0.89	SXSXS
5011	1-1/2"	0.58	1.05	1.05	1.05	SXSXS
5011	2"	0.82	1.25	1.25	1.25	SXSXS
5011	2-1/2"	1.58	1.53	1.53	1.53	SXSXS
5011	3"	2.14	1.84	1.84	1.84	SXSXS
5011-R	3/4"x3/4"x1"	0.14	0.70	0.70	0.73	SXSXS
5011-R	1"x1"x3/4"	0.16	0.61	0.61	0.94	SXSXS
5011-R	1"x3/4"x1"	0.20	0.76	0.99	0.78	SXSXS
5011-R	1"x3/4"x3/4"	0.16	0.60	0.87	0.77	SXSXS
5011-R	1-1/4"x1-1/4"x1"	0.24	0.73	0.73	0.89	SXSXS
5011-R	1-1/4"x1-1/4"x3/4"	0.20	0.60	0.60	0.89	SXSXS
5011-R	1-1/4"x1"x1-1/4"	0.28	0.88	1.03	0.87	SXSXS
5011-R	1-1/4"x1"x1"	0.24	0.71	0.90	0.89	SXSXS
5011-R	1-1/4"x1"x3/4"	0.20	0.61	0.76	0.89	SXSXS
5011-R	1-1/4"x1-1/4"x1-1/2"	0.44	1.01	1.01	0.88	SXSXS
5011-R	1-1/2"x1-1/2"x1-1/4"	0.46	0.89	0.89	1.04	SXSXS
5011-R	1-1/2"x1-1/2"x1"	0.54	0.77	0.77	0.96	SXSXS
5011-R	1-1/2"x1-1/2"x3/4"	0.50	0.67	0.67	1.04	SXSXS
5011-R	1-1/2"x1-1/4"x1"	0.40	0.72	0.91	1.01	SXSXS
5011-R	1-1/2"x1-1/4"x3/4"	0.36	0.60	0.78	1.02	SXSXS
5011-R	1-1/2"x1-1/2"x2"	0.88	1.30	1.30	1.14	SXSXS
5011-R	2"x2"x1-1/2"	0.86	1.06	1.06	1.37	SXSXS
5011-R	2"x2"x1-1/4"	0.67	1.00	1.00	1.28	SXSXS
5011-R	2"x2"x1"	0.72	0.80	0.80	1.25	SXSXS
5011-R	2"x2"x3/4"	0.68	0.70	0.70	1.25	SXSXS
5011-R	2-1/2"x2-1/2"x2"	1.32	1.26	1.26	1.53	SXSXS
5011-R	2-1/2"x2-1/2"x1-1/2"	1.21	1.06	1.06	1.53	SXSXS
5011-R	2-1/2"x2-1/2"x1-1/4"	1.12	0.91	0.91	1.53	SXSXS
5011-R	2-1/2"x2-1/2"x1"	1.05	0.74	0.74	1.53	SXSXS
5011-R	3"x3"x2-1/2"	1.71	1.53	1.53	1.84	SXSXS
5011-R	3"x3"x2"	1.56	1.26	1.26	1.84	SXSXS
5011-R	3"x3"x1-1/2"	1.39	1.06	1.06	1.82	SXSXS

Note: All NIBCO reducing tees are molded to size, not fabricated.

# BlazeMaster® Fire Protection Fittings – STANDARD

## UNIONS

### 5033-E

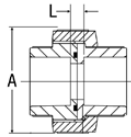

### Unions (O-ring Material EPDM)

UNIV. FIG. NO.	NOM. NOM. SIZE	APPROX. NET WT./LBS.	DIM. A INCHES	DIM. L INCHES	JOINT
5033-E	3/4"	0.27	2.46	0.43	SXS
5033-E	1"	0.40	2.70	0.43	SXS
5033-E*	1-1/4"	0.87	3.31	0.79	SXS
5033-E*	1-1/2"	0.93	3.58	0.80	SXS
5033-E*	2"	1.83	3.82	0.80	SXS

\* Future Offering

**BlazeMaster®**  
FIRE SPRINKLER FITTINGS

BlazeMaster® is a registered trademark of The Lubrizol Corporation.

## CPVC Threaded Fire Protection Fittings

Adapters .....	15-16
Crosses .....	17
Elbows .....	17
Tees .....	18
Test Plugs .....	19

## CPVC Transition Fittings

IPS to CTS Transition Fittings.....	19
-------------------------------------	----

# BlazeMaster® Fire Protection Fittings – THREADED

## ADAPTERS

### 5003-BI

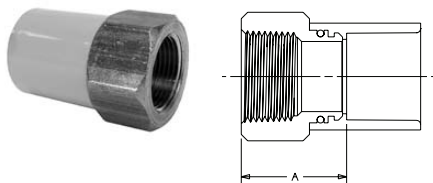

### Female Adapters with Metal Thread Insert

UNIV. FIG. NO.	NOM. SIZE	APPROX. NET WT./LBS.	DIM. A INCHES	JOINT
5003-BI	3/4"	0.28	1.19	SXFNPT
5003-BI	1"	0.63	1.59	SXFNPT
5003-BI	1-1/4"	1.02	1.96	SXFNPT
5003-BI	1-1/2"	1.26	1.98	SXFNPT
5003-BI	2"	1.98	1.99	SXFNPT

### 5003-2-BI

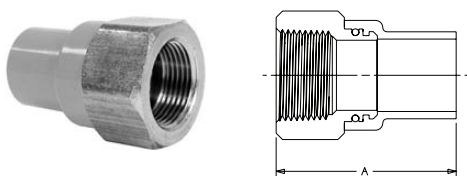

### Spigot Female Adapters with Metal Thread Insert

UNIV. FIG. NO.	NOM. SIZE	APPROX. NET WT./LBS.	DIM. A INCHES	JOINT
5003-2-BI	3/4"	0.28	2.00	SPGXFNPT
5003-2-BI	1"	0.61	2.72	SPGXFNPT

### 5004-BI

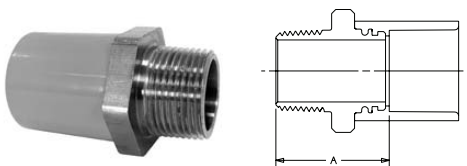

### Male Adapters with Metal Thread Insert

UNIV. FIG. NO.	NOM. SIZE	APPROX. NET WT./LBS.	DIM. A INCHES	JOINT
5004-BI	3/4"	0.22	1.35	SxMNPT
5004-BI	1"	0.46	1.82	SxMNPT
5004-BI	1-1/4"	0.74	2.05	SxMNPT
5004-BI	1-1/2"	1.06	2.14	SxMNPT
5004-BI	2"	1.80	2.31	SxMNPT

### 5003-BI-BSP

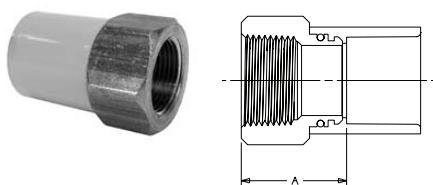

### Female Adapters with Metal BSP Thread Insert

UNIV. FIG. NO.	NOM. SIZE	APPROX. NET WT./LBS.	DIM. A INCHES	JOINT
5003-BI-BSP	1"	0.63	1.59	SXBSPT
5003-BI-BSP	1-1/4"	1.02	1.96	SXBSPT
5003-BI-BSP	1-1/2"	1.26	1.98	SXBSPT
5003-BI-BSP	2"	1.98	1.99	SXBSPT

**BlazeMaster®**  
FIRE SPRINKLER FITTINGS

BlazeMaster® is a registered trademark of The Lubrizol Corporation.

# BlazeMaster® Fire Protection Fittings – THREADED

## ADAPTERS

### 5003-S-BI

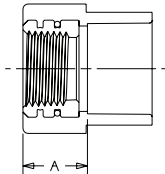

### Female Sprinkler Head Adapters with Metal Thread Insert

UNIV. FIG. NO.	NOM. SIZE	APPROX. NET WT./LBS.	DIM. A INCHES	JOINT
5003-S-BI	3/4"x1/2"	0.16	0.72	SXFNPT
5003-S-BI	1"x1/2"	0.18	0.73	SXFNPT
5003-S-BI	1"x3/4"	0.18	0.93	SXFNPT

### 5003-2-S-BI

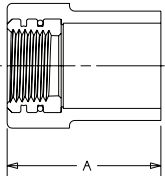

### Spigot Female Sprinkler Head Adapters with Metal Thread Insert

UNIV. FIG. NO.	NOM. SIZE	APPROX. NET WT./LBS.	DIM. A INCHES	JOINT
5003-2-S-BI	3/4"x1/2"	0.15	1.53	SPGXFNPT
5003-2-S-BI	1"x1/2"	0.16	1.84	SPGXFNPT

### 5003-S-BT

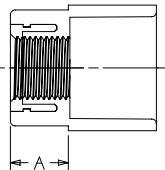

### BRASTIC® Female Sprinkler Head Adapters with Metal Starter Thread

UNIV. FIG. NO.	NOM. SIZE	APPROX. NET WT./LBS.	DIM. A INCHES	JOINT
5003-S-BT	3/4" x 1/2"	0.15	.75	SXFNPT
5003-S-BT	1" x 1/2"	0.17	.75	SXFNPT



# BlazeMaster® Fire Protection Fittings – THREADED

## CROSSES

**5035-3-S-BI-S**  
**5035-3-S-BI-L**

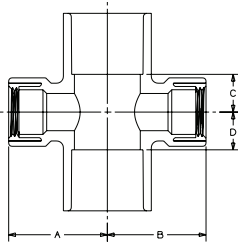

### Sprinkler Head Back To Back Crosses with Metal Thread Inserts

UNIV. FIG. NO.	NOM. SIZE	APPROX. NET WT./LBS.	DIM. A INCHES	DIM. B INCHES	DIM. C INCHES	DIM. D INCHES	JOINT
5035-3-S-BI-S	1x1"x1/2"x1/2" 3-3/8" Take Out	0.46	1.69	1.69	0.62	0.62	SXSXFNPTXFNPT
5035-3-S-BI-L	1x1"x1/2"x1/2" 3-5/8" Take Out	0.48	1.81	1.81	0.62	0.62	SXSXFNPTXFNPT

## ELBOWS

**5007-3-S-BI**

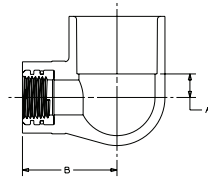

### Sprinkler Head 90 with Metal Thread Insert

UNIV. FIG. NO.	NOM. SIZE	APPROX. NET WT./LBS.	DIM. A INCHES	DIM. B INCHES	JOINT
5007-3-S-BI	3/4"x1/2"	0.22	0.56	1.62	SxFNPT
5007-3-S-BI	1"x1/2"	0.27	0.50	1.76	SxFNPT
5007-3-S-BI	1"x3/4"	0.26	0.59	1.88	SxFNPT
5007-3-S-BI	1-1/4"x1/2"	0.30	0.48	1.95	SxFNPT

# BlazeMaster® Fire Protection Fittings – THREADED

## TEES

**5011-3-3-S-BI-S**

**5011-3-3-S-BI-L**

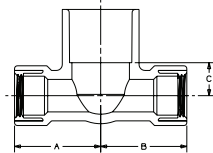

### Back To Back Tees with Metal Thread Inserts

UNIV. FIG. NO.	NOM. SIZE	APPROX. NET WT./LBS.	DIM. A INCHES	DIM. B INCHES	DIM. C INCHES	JOINT
5011-3-3-S-BI-S	1/2"x1/2"x1" 3-3/8" Take Out	0.44	1.69	1.69	.62	FNPTXFNPTXS
5011-3-3-S-BI-L	1/2"x1/2"x1" 3-5/8" Take Out	0.46	1.81	1.81	.62	FNPTXFNPTXS

**5012-S-BI**

**5012R-S-BI**

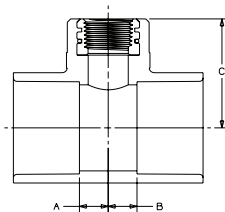

### Sprinkler Head Tees with Metal Thread Insert

UNIV. FIG. NO.	NOM. SIZE	APPROX. NET WT./LBS.	DIM. A INCHES	DIM. B INCHES	DIM. C INCHES	JOINT
5012-S-BI	3/4"x3/4"x1/2"	0.22	0.42	0.42	1.60	SXSXFNPT
5012-S-BI	1"	0.44	0.80	0.80	1.48	SXSXFNPT
5012-S-BI	1"x1"x1/2"	0.29	0.41	0.41	1.76	SXSXFNPT
5012-S-BI	1-1/4"x1-1/4"x1/2"	0.34	0.52	0.52	1.95	SXSXFNPT
5012-S-BI	1-1/2"x1-1/2"x1/2"	0.46	0.45	0.45	2.13	SXSXFNPT
5012-S-BI	2"x2"x1/2"	0.58	0.47	0.47	1.68	SXSXFNPT
5012R-S-BI	1"x3/4"x1/2"	0.28	0.46	0.83	1.69	SXSXFNPT
5012R-S-BI	1-1/4"x1"x1/2"	0.34	0.51	0.63	1.94	SXSXFNPT
5012R-S-BI	1-1/2"x1-1/4"x1/2"	0.47	0.46	0.67	2.13	SXSXFNPT
5012R-S-BI	2"x1-1/2"x1/2"	0.58	0.48	0.78	2.38	SXSXFNPT

**5014R-S-BI**

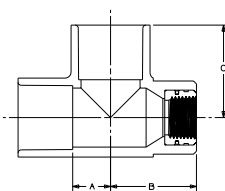

### Sprinkler Head Tees with Metal Thread Insert

UNIV. FIG. NO.	NOM. SIZE	APPROX. NET WT./LBS.	DIM. A INCHES	DIM. B INCHES	DIM. C INCHES	JOINT
5014R-S-BI	1"x1/2"x1"	0.30	0.71	1.74	1.90	SXFNPTXS

# BlazeMaster® Fire Protection Fittings – THREADED

## TEST PLUG

450-005

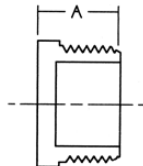

### Test Plugs

UNIV. FIG. NO.	NOM. SIZE	APPROX. NET WT./LBS.	DIM. A INCHES	JOINT
450-005	1/2"	0.03	1.06	MPT

Note: Test plug is white PVC Schedule 40 material and is intended for testing the system only. Test plug should not be included as a component in the completed system.

## IPS TO CTS TRANSITION FITTINGS

**FLOWGUARD GOLD**  
CPVC

FOR USE IN MULTI-PURPOSE NFPA-13D SYSTEMS (WHERE APPROVED).

4701-T

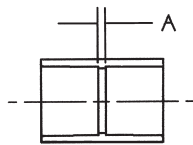
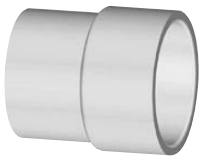

### Transition Couplings (Slip IPS x Slip CTS)

NOM. SIZE		APPROX. NET WT./LBS.	DIM. A INCHES
3/4	(IPS) x 3/4 (CTS)	.039	1/8
1	(IPS) x 1 (CTS)	.068	1/8
2	(IPS) x 2 (CTS)	.330	1/8

4718-T

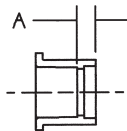

### Transition Bushings (Spigot IPS x Slip CTS)

NOM. SIZE		APPROX. NET WT./LBS.	DIM. A INCHES
1	(IPS) x 1 (CTS)	.030	9/32
1 1/4	(IPS) x 1 1/4 (CTS)	.057	1/4
1 1/2	(IPS) x 1 1/2 (CTS)	.070	3/16
2	(IPS) x 2 (CTS)	.111	1/8

Note: For joining BlazeMaster® and FlowGuard Gold® pipe and fittings, use NIBCO® FP-1000 One-Step Cement.

IPS = Iron Pipe Size

CTS = Copper Tube Size

FlowGuard Gold® is a registered trademark of The Lubrizol Corporation.  
BlazeMaster® is a registered trademark of The Lubrizol Corporation.

**BlazeMaster**  
FIRE SPRINKLER FITTINGS

# BlazeMaster® Fire Protection Fittings – ACCESSORIES

## CEMENT AND ACCESSORIES



### Solvent Cement

FIG. NO.	SIZE	DESCRIPTION	LBS./CASE
5097Q	Quart	NIBCO FP-1000 One Step Cement	27
5097P	Pint	NIBCO FP-1000 One Step Cement	14
C5097Q	Quart	NIBCO FP-1000 One Step Cement Canada compliant label	27
C5097P	Pint	NIBCO FP-1000 One Step Cement Canada compliant label	14

**Note:** Pint can lid is the correct size dauber for 3/4" through 1-1/4" pipe and fitting assembly; quart can lid is the correct size dauber for 1-1/2" through 3" pipe and fittings.



### Empty Can

FIG. NO.	SIZE	DESCRIPTION	LBS./CASE
5098Q	Quart	Empty Can Quart	3
5098P	Pint	Empty Can Pint	2
5098G	Gallon	Empty Can Gallon	5



### Brush

FIG. NO.	SIZE	DESCRIPTION	LBS./CASE
5096	NA	Brush BP-1	11



### Roller

FIG. NO.	SIZE	DESCRIPTION	LBS./CASE
5097	NA	Roller 6020	4



### Dauber

FIG. NO.	SIZE	DESCRIPTION	LBS./CASE
5093S	Small	Dauber CM-75 (for pipe sizes 3/4" - 1-1/4")	2
5093L	Large	Dauber CM-150 (for pipe sizes 1-1/4" - 3")	2

# BlazeMaster® Fire Protection Fittings – ACCESSORIES

## CEMENT AND ACCESSORIES



### Thread Sealant

FIG. NO.	SIZE	DESCRIPTION	LBS./CASE	CANS/CASE
5094	Half Pint	Thread Sealant	24.0	24
5094	Pint	Thread Sealant	24.0	12
5094	Quart	Thread Sealant	38.4	12

**NOTE:** Only use thread sealant that is compatible with NIBCO manufactured BlazeMaster® CPVC fittings. Thread sealants which carry the **FGG-BM-CZ** mark have been determined to be chemically compatible.



### PTFE Tape

FIG. NO.	SIZE	DESCRIPTION	LBS./CASE
5099	1/2"x260"	PTFE Tape	11

FGG/BM/CZ™ is a trademark of The Lubrizol Corporation.  
BlazeMaster® is a registered trademark of The Lubrizol Corporation.

**BlazeMaster®**  
FIRE SPRINKLER FITTINGS

# Typical Residential Riser

NIBCO valves and fittings that are typically used with CPVC *BlazeMaster®* pipe.

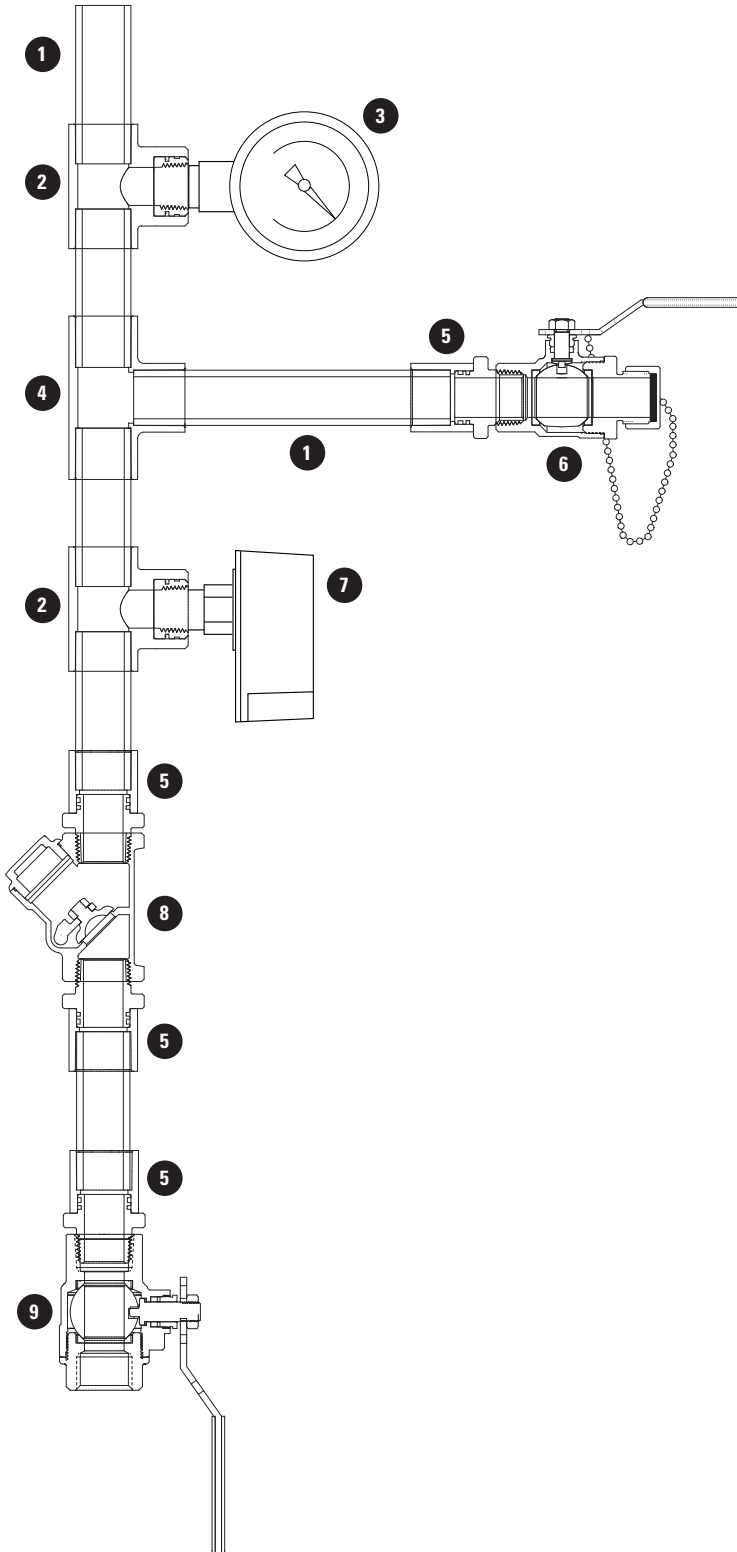

- 1 CPVC *BlazeMaster®* Pipe
- 2 NIBCO #5012-S-BI
- 3 Pressure Gauge
- 4 NIBCO #5011
- 5 NIBCO #5004-BI
- 6 NIBCO Hose End  
T-585-70-HC / 66-HC
- 7 Flow Switch
- 8 NIBCO Check  
T-480, T-480-Y, T-413-Y, TI3
- 9 NIBCO Isolation  
T-585-70 / 66 / UL / IC  
MTT-585-70, T-FP-600

BlazeMaster® is a registered trademark of The Lubrizol Corporation.

**BlazeMaster®**  
FIRE SPRINKLER FITTINGS

# Valves for Residential Fire Protection

## ISOLATION VALVES

<p><b>T-585-70 / 66</b></p>  <p>600 PSI CWP 150 PSI SWP 2-Piece Bronze Body Full Port Bronze or SS Stem Chrome/Nickel Plate or SS Ball Threaded Connection MSS SP-110 1/4" – 2"</p>	<p><b>KT-580-70-UL KT-585-70-UL</b></p>  <p>300 PSI Non-Shock Cold Water 2-Piece Bronze Body Full Port 1/4" – 1", Conventional Port 1-1/4" – 3" Bronze Stem Chrome/Nickel Plate Ball Threaded Connection MSS SP-110, UL/FM 1/4" – 3"</p>	<p><b>MTT-585-70</b></p>  <p>600 PSI CWP 150 PSI SWP 2-Piece Bronze Body Full Port Bronze Stem, Chrome Chrome/Nickel Plate Ball Male x Female Threaded End Connection MSS SP-110 1/2" – 2"</p>
<p><b>T-FP-600A</b></p>  <p>600 PSI CWP 2-Piece Brass Body Full Port Bronze or Brass Stem Chrome/Nickel Plate Ball Threaded Connection MSS SP-110, UL 1/4" – 2"</p>	<p><b>T-685-80-LF</b></p>  <p>Lead-Free* 600 PSI CWP 2-Piece Body Full Port Copper Silicon Alloy Ball/Stem Threaded Connection MSS SP-110 1/2" – 2"</p>	

## CHECK VALVES

<p><b>T-413-Y/W</b></p>  <p>200 PSI CWP Horizontal Swing Check Bronze Body PTFE or Buna Disc Integral Seat Threaded Connection MSS SP-80 1/2" – 2"</p> <p>Lead-Free* version available as T-413-Y-LF</p>	<p><b>T-480-Y T-480</b></p>  <p>250 PSI CWP In-Line Lift Type Check Bronze Body PTFE or Buna Disc Integral Seat Threaded Connection 3/8" – 2"</p> <p>Lead-Free* version available as T-480-Y-LF</p>
---	--

## HOSE END DRAIN

<p><b>T-585-70-HC / 66-HC</b></p>  <p>600 PSI CWP Ball Valve with Cap &amp; Chain 2-Piece Bronze Body Full Port Bronze or SS Stem Chrome Plated or SS Ball Threaded Connection MSS SP-110 1/2" – 3/4"</p>
--

\* Lead-Free refers to the wetted surface of pipe, fittings and fixtures in potable water systems that have a weighted average lead content <0.25%. Source: California Health & Safety Code (116875); Vermont Act 193.

NOTE: To view NIBCO's entire fire protection valve offering, visit [www.nibco.com](http://www.nibco.com).

BlazeMaster® is a registered trademark of The Lubrizol Corporation.

**BlazeMaster®**  
FIRE SPRINKLER FITTINGS

## Review – Do's & Don'ts

### Do's

- Installation should be made only by a qualified installer or contractor in accordance with all applicable codes and requirements.
- Read and follow the installation instructions.
- Follow recommended safe work practices.
- Make certain that thread sealants, gasket lubricants, or firestop materials are compatible with CPVC.
- Keep pipe and fittings in original packaging until needed.
- Cover pipe and fittings with an opaque tarp if stored outdoors.
- Follow proper handling procedures.
- Use tools specifically designed for use with plastic pipe and fittings.
- Use the proper solvent cement and follow application instructions.
- Use a drop cloth to protect interior finishes.
- Cut the pipe ends square.
- Deburr and bevel the pipe end with a chamfering tool.
- Rotate the pipe 1/4 turn when bottoming pipe in fitting socket.
- Make certain no solvent cement is on sprinkler head and adapter threads.
- Make certain that solvent cement does not run and plug the sprinkler head orifice.
- Follow the manufacturer's recommended cure times prior to pressure testing.
- Fill lines slowly and only at a proper pressure.
- Bleed the air from the system prior to pressure testing.
- Support sprinkler head properly to prevent lift up of the head through the ceiling when activated.
- Keep threaded rod within 1/16" of the pipe or use a surge arrester.
- Install NIBCO® **BlazeMaster**® CPVC Fire Sprinkler Products in wet systems only.
- Use only insulation and/or glycerin and water solutions for freeze protection.
- Allow for movement due to expansion and contraction.
- Ensure installers have been properly trained per the NIBCO **BlazeMaster**® CPVC Fire Sprinkler System Installation and Design Manual and renew your training every three years at a minimum.

### Don'ts

- Do not use edible oils as a gasket lubricant.
- Do not use petroleum or solvent-based sealants, lubricants, or fire stop materials.
- Do not use any glycol-based solutions as an anti-freeze.
- Do not contaminate the CPVC system with cutting oils or compressor oils.
- Do not mix glycerin and water solutions in contaminated containers.
- Do not use solvent cement that exceeds its shelf life or has become discolored or jellied.
- Do not allow solvent cement to plug the sprinkler head orifice.
- Do not connect rigid metal couplers to CPVC grooved adapters.
- Do not thread or groove CPVC pipe.
- Do not use solvent cement near sources of heat, open flame, or when smoking.
- Do not pressure test with air.
- Do not pressure test until recommended cure times are met.
- Do not exceed proper pressure for testing.
- Do not use ratchet cutters below 50°F.
- Do not use CPVC pipe that has been stored outdoors, unprotected and is faded in color.
- Do not allow threaded rod to come in contact with the pipe.
- Do not install NIBCO **BlazeMaster**® CPVC Fire Sprinkler Products in cold weather without allowing for expansion.
- Do not install NIBCO **BlazeMaster**® CPVC Fire Sprinkler Products in dry systems.
- Do not allow puddling of cement in fittings and pipe.
- Do not use dull or broken cutting tool blades when cutting pipe.



# CPVC Cross Reference Sheet

## STANDARD FITTINGS

	NIBCO FIG. NO.	SIZE	SPEARS FIG. NO.	TYCO FIG. NO.	
<b>ADAPTER</b>	5001-G	1-1/4"	4233-012	80160	
	5001-G	1-1/2"	4233-015	80161	
	5001-G	2"	4233-020	80162	
	5001-G	2-1/2"	4233-025	80163	
	5001-G	3"	4233-030	80164	
<b>BUSHINGS</b>	5018	1"x3/4"	4237-131	80200	
	5018	1-1/4"x1"	4237-168	80202	
	5018	1-1/4"x3/4"	4237-167	80201	
	5018	1-1/2"x1-1/4"	4237-212	80205	
	5018	1-1/2"x1"	4237-211	80204	
	5018	1-1/2"x3/4"	4237-210	80203	
	5018	2"x1-1/2"	4237-251	80209	
	5018	2"x1-1/4"	4237-250	80208	
	5018	2"x1"	4237-249	80207	
	5018	2"x3/4"	4237-248	80206	
	5018	2-1/2"x2"	4237-292	80211	
	5018	2-1/2"x1-1/2"	4237-291	80213	
	5018	2-1/2"x1-1/4"	4237-290	80214	
	5018	2-1/2"x1"	N/A	80215	
	5018	3"x2-1/2"	4237-339	80212	
	5018	3"x2"	4237-338	80210	
	5018	3"x1-1/2"	N/A	N/A	
	<b>CAPS</b>	5017	3/4"	4247-007	80100
		5017	1"	4247-010	80101
		5017	1-1/4"	4247-012	80102
		5017	1-1/2"	4247-015	80103
5017		2"	4247-020	80104	
5017		2-1/2"	4247-025	80105	
5017		3"	4247-030	80106	
<b>COUPLINGS</b>	5001	3/4"	4229-007	80075	
	5001	1"	4229-010	80076	
	5001	1-1/4"	4229-012	80077	
	5001	1-1/2"	4229-015	80078	
	5001	2"	4229-020	80079	
	5001	2-1/2"	4229-025	80080	
	5001	3"	4229-030	80081	
	5001-R	1"x3/4"	4229-131	80220	
	5001-R	1-1/4"x1"	4229-168	N/A	
	5001-R	1-1/2"x3/4"	4229-210	N/A	
	5001-R	1-1/2"x1"	4229-211	N/A	
5001-R	1-1/2"x1-1/4"	4229-212	N/A		
5001-R	2"x1"	4229-249	N/A		
5001-R	2"x1-1/2"	4229-251	N/A		
<b>CROSSES</b>	5035	3/4"	4220-007	80009	
	5035	1"	4220-010	80010	
	5035	1-1/4"	4220-012	80011	
	5035	1-1/2"	4220-015	80012	

## STANDARD FITTINGS

	NIBCO FIG. NO.	SIZE	SPEARS FIG. NO.	TYCO FIG. NO.
<b>CROSSES</b>	5035	2"	4220-020	80013
	5035	2-1/2"	4220-025	80014
	5035	3"	4220-030	80008
	5035-R	1"x3/4"x1"x3/4"	4220-131	80015
	5006	3/4"	4217-007	80050
<b>ELBOWS</b>	5006	1"	4217-010	80051
	5006	1-1/4"	4217-012	80052
	5006	1-1/2"	4217-015	80053
	5006	2"	4217-020	80054
	5006	2-1/2"	4217-025	80055
	5006	3"	4217-030	80056
	5007	3/4"	4206-007	80025
	5007	1"	4206-010	80026
	5007	1-1/4"	4206-012	80027
	5007	1-1/2"	4206-015	80028
	5007	2"	4206-020	80039
	5007	2-1/2"	4206-025	80030
	5007	3"	4206-030	80031
	5007-R	1"x3/4"	4206-131	80032
	5019-H	3/4"	4253-007	N/A
	5019-H	1"	4253-010	N/A
	5019-H	1-1/4"	4253-012	N/A
	5019-H	1-1/2"	4253-015	N/A
	5019-H	2"	4253-020	N/A
	5019-H	2-1/2"	4253-025	N/A
	5019-H	3"	4253-030	N/A
5051-A	3"	4254-030	N/A	
5051-2-A	3"	4256-030	N/A	
5051-H	3/4"	4251-007	N/A	
5051-H	1"	4251-010	N/A	
5051-H	1-1/4"	4251-012	N/A	
5051-H	1-1/2"	4251-015	N/A	
5051-H	2"	4251-020	N/A	
5051-H	2-1/2"	4251-025	N/A	
5051-H	3"	N/A	N/A	
<b>FLANGES</b>	5011	3/4"	4201-007	8000
	5011	1"	4201-010	8001
	5011	1-1/4"	4201-012	8002
	5011	1-1/2"	4201-015	8003
	5011	2"	4201-020	80004
	5011	2-1/2"	4201-025	8005
	5011	3"	4201-030	80006
	5011-R	3/4"x3/4"x1"	4201-102	80132
	5011-R	1"x1"x3/4"	4201-131	80260
	5011-R	1"x3/4"x1"	4201-126	80134
	<b>TEES</b>	5011	3/4"	4201-007
5011		1"	4201-010	8001
5011		1-1/4"	4201-012	8002
5011		1-1/2"	4201-015	8003
5011		2"	4201-020	80004
5011		2-1/2"	4201-025	8005
5011		3"	4201-030	80006
5011-R		3/4"x3/4"x1"	4201-102	80132
5011-R		1"x1"x3/4"	4201-131	80260
5011-R		1"x3/4"x1"	4201-126	80134

**BlazeMaster®**  
FIRE SPRINKLER FITTINGS

BlazeMaster® is a registered trademark of The Lubrizol Corporation.

# CPVC Cross Reference Sheet

## STANDARD FITTINGS

	NIBCO FIG. NO.	SIZE	SPEARS FIG. NO.	TYCO FIG. NO.
<b>TEES</b>	5011-R	1"x3/4"x3/4"	4201-125	80133
	5011-R	1-1/4"x1-1/4"x1"	4201-168	80262
	5011-R	1-1/4"x1-1/4"x3/4"	4201-167	80261
	5011-R	1-1/4"x1"x1-1/4"	4201-159	80137
	5011-R	1-1/4"x1"x1"	4201-158	80136
	5011-R	1-1/4"x1"x3/4"	4201-157	80135
	5011-R	1-1/4"x1-1/4"x1-1/2"	4201-169	80138
	5011-R	1-1/2"x1-1/2"x1-1/4"	4201-212	80275
	5011-R	1-1/2"x1-1/2"x1"	4201-211	80264
	5011-R	1-1/2"x1-1/2"x3/4"	4201-210	80263
	5011-R	1-1/2"x1-1/4"x1"	4201-202	80140
	5011-R	1-1/2"x1-1/4"x3/4"	4201-201	80140
	5011-R	1-1/2"x1-1/2"x2"	4201-213	N/A
	5011-R	2"x2"x1-1/2"	4201-251	80274
	5011-R	2"x2"x1-1/4"	4201-250	80267
	5011-R	2"x2"x1"	4201-249	80266
	5011-R	2"x2"x3/4"	4201-248	80265
	5011-R	2-1/2"x2-1/2"x2"	4201-292	80276
	5011-R	2-1/2"x2-1/2"x1-1/2"	4201-291	80273
	5011-R	2-1/2"x2-1/2"x1-1/4"	4201-290	80272
5011-R	2-1/2"x2-1/2"x1"	4201-289	80271	
5011-R	3"x3"x2-1/2"	4201-339	80269	
5011-R	3"x3"x2"	4201-338	80268	
5011-R	3"x3"x1-1/2"	4201-337	80270	
<b>UNIONS</b>	5033-E	3/4"	4257-007	N/A
	5033-E	1"	4257-010	N/A
	5033-E	1-1/4"	4257-012	N/A
	5033-E	1-1/2"	4257-015	N/A
	5033-E	2"	4257-020	N/A

## THREADED FITTINGS

	NIBCO FIG. NO.	SIZE	SPEARS FIG. NO.	TYCO FIG. NO.	
<b>ADAPTERS</b>	5003-BI	3/4"	4235-007	80142	
	5003-BI	1"	4235-010	80145	
	5003-BI	1-1/4"	4235-012	80146	
	5003-BI	1-1/2"	4235-015	80147	
	5003-BI	2"	4235-020	80148	
	5003-2-BI	3/4"	4278-007	N/A	
	5003-2-BI	1"	4278-010	N/A	
	5003-S-BI	3/4"x1/2"	4235-101	80175E or 80175W	
	5003-S-BI	1"x1/2"	4235-130	80176E or 80175W	
	5003-S-BI	1"x3/4"	4235-131	80179	
	5003-2-S-BI	3/4"x1/2"	4238-101	N/A	
	5003-2-S-BI	1"x1/2"	4238-130	N/A	
	5003-S-BT	3/4"x1/2"	N/A	N/A	
	5003-S-BT	1"x1/2"	N/A	N/A	
	5003-BI-BSP	1"	N/A	N/A	
	5003-BI-BSP	1-1/4"	N/A	N/A	
	5003-BI-BSP	1-1/2"	N/A	N/A	
	5003-BI-BSP	2"	N/A	N/A	
	5004-BI	3/4"	N/A	80157	
	5004-BI	1"	N/A	80158	
	5004-BI	1-1/4"	N/A	N/A	
	5004-BI	1-1/2"	N/A	N/A	
	5004-BI	2"	N/A	N/A	
	<b>CROSSES</b>	5035-3-S-BI-S	1"x1"x1/2"x1/2"	N/A	80462
		5035-3-S-BI-L	1"x1"x1/2"x1/2"	N/A	80463
<b>ELBOWS</b>	5007-3-S-BI	3/4"x1/2"	4207-101	80199	
	5007-3-S-BI	1"x1/2"	4207-130	80198	
	5007-3-S-BI	1"x3/4"	4207-131	N/A	
	5007-3-S-BI	1-1/4"x1/2"	4207-166	N/A	
	5011-3-3-S-BI-S	1/2"x1/2"x1"	N/A	80460	
	5011-3-3-S-BI-L	1/2"x1/2"x1"	N/A	80459	
	5012-S-BI	1"	4202-010	N/A	
	5012-S-BI	3/4"x3/4"x1/2"	4202-101	80250	
	5012-R-S-BI	1"x3/4"x1/2"	4202-124	N/A	
	5012-S-BI	1"x1"x1/2"	4202-130	80251	
<b>TEES</b>	5012-R-S-BI	1"x1/2"x1"	4203-122	N/A	
	5012-R-S-BI	1-1/4"x1"x1/2"	4202-156	80256	
	5012-S-BI	1-1/4"x1-1/4"x1/2"	4202-166	80252	
	5012-R-S-BI	1-1/2"x1-1/4"x1/2"	4202-199	80257	
	5012-S-BI	1-1/2"x1-1/2"x1/2"	4202-209	80254	
	5012-S-BI	2"x2"x1/2"	4202-247	80253	
	5012-R-S-BI	2"x1-1/2"x1/2"	4202-237	80258	
	<b>TEST PLUG</b>	450-005	1/2"	4250-005	N/A

## NIBCO® Fire Protection Expertise you can count on!

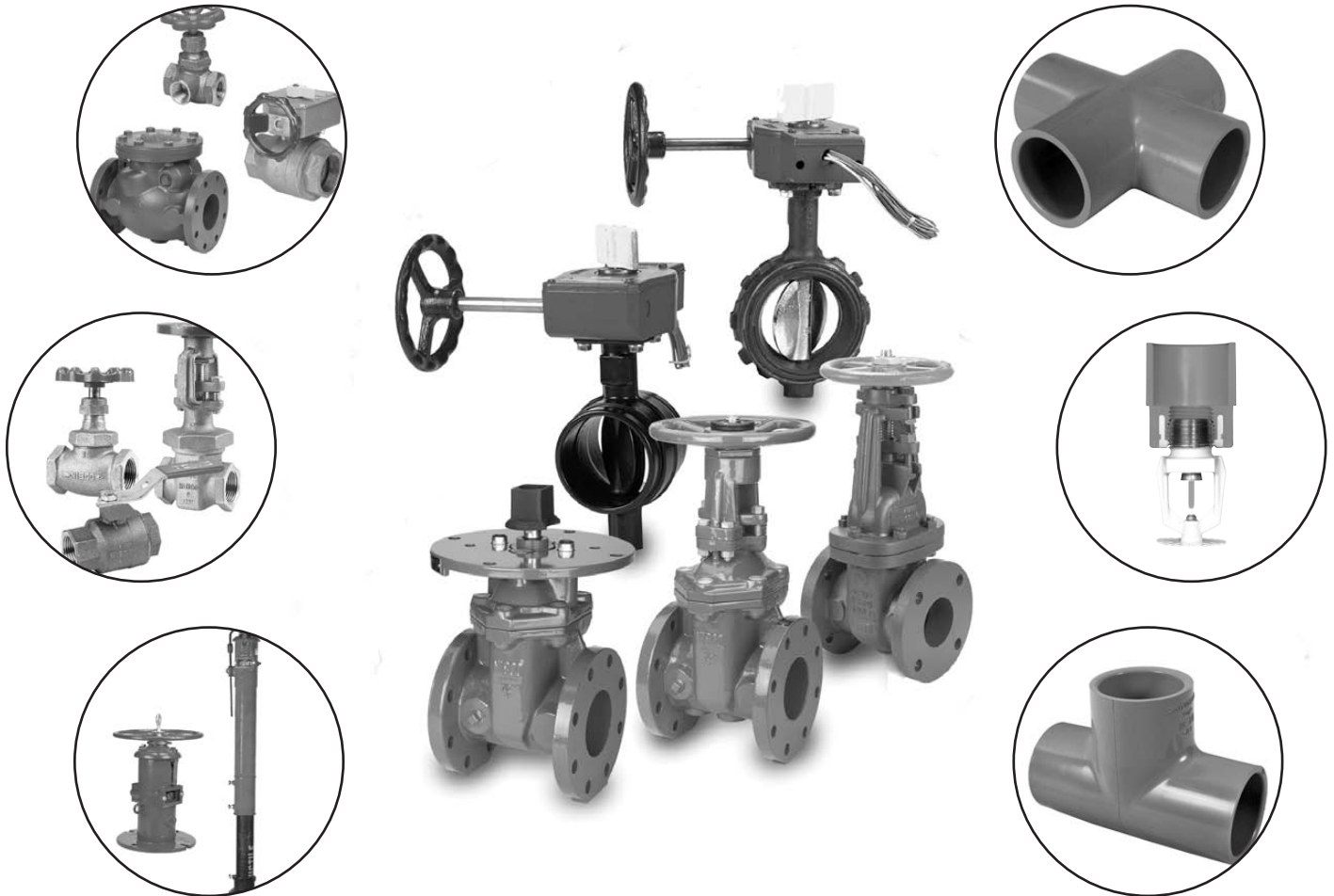

NIBCO represents a tradition of quality, service, and highly specified valves for the fire protection market. We offer a winning combination of fire protection solutions that meet industry standards including UL, ULC, FMRC and NYC.

# NOTES

# NOTES



# NIBCO® BlazeMaster® Warranty

## NIBCO INC. LIMITED WARRANTY

Applicable to NIBCO INC. CPVC Fire Protection Plastic Fittings

NIBCO INC. warrants each NIBCO® BlazeMaster® Fire Protection CPVC plastic fitting to be free from defects in materials and workmanship under normal use and service for a period of ten (10) years from date of purchase.

In the event any defect occurs which the owner believes is covered by this warranty, the owner should immediately contact NIBCO Technical Services, either in writing or by telephone at 1.888.446.4226 or 1.574.295.3000. The owner will be instructed to return said product, at the owner's expense, to NIBCO INC., or an authorized representative for inspection. In the event said inspection discloses to the satisfaction of NIBCO INC. that said fitting or valve is defective, a replacement shall be mailed free of charge to the owner, and NIBCO INC. shall further pay the installing contractor the sum of ten (\$10.00) dollars to apply on the cost of installation of said replacement fitting.

TO THE EXTENT PERMITTED BY LAW, THIS WARRANTY SPECIFICALLY EXCLUDES INCIDENTAL AND CONSEQUENTIAL DAMAGES OF EVERY TYPE AND DESCRIPTION RESULTING FROM ANY CLAIMED DEFECT IN MATERIAL OR WORKMANSHIP, INCLUDING BUT NOT LIMITED TO, PERSONAL INJURIES AND PROPERTY DAMAGES.

Some states or countries do not allow the exclusion or limitation of incidental or consequential damages so these limitations may not apply to you.

TO THE EXTENT PERMITTED BY LAW, IMPLIED WARRANTIES OF MERCHANTABILITY AND FITNESS FOR A PARTICULAR PURPOSE ARE LIMITED IN DURATION.

This warranty gives you specific legal rights, and you may also have other rights which vary from state to state and country to country.

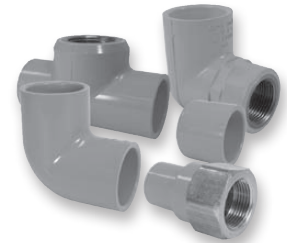

BlazeMaster® is a registered trademark of The Lubrizol Corporation.

## How to Order

State quantity, figure number and size for each valve or fitting you wish to order. See individual catalog pages for specific or special product designations.

### HOW MANY TO ORDER

NIBCO® valves and fittings are decimal packed for your convenience in handling, shipping and stock-keeping. Number in master carton varies with item.

### POLICY ON RETURNS TO FACTORY

No NIBCO valves and fittings are to be returned without prior written agreement. Transportation must be prepaid. A 20% charge will be made to cover cost of rehandling and reinspection.

### TECHNICAL ASSISTANCE

Engineers, contractors, wholesalers or manufacturers may obtain special or technical assistance from any factory representative of NIBCO. Write, fax or phone.

NIBCO INC.  
World Headquarters  
1516 Middlebury Street  
Elkhart, IN 46516-4740  
USA

PH: 1.574.295.3000 or 1.888.446.4226  
FAX: 1.574.295.3307 or 1.888.336.4226

To the best of our knowledge, the information contained in this publication is accurate. However, NIBCO does not assume any liability whatsoever for the accuracy or completeness of such information. Final determinations of the suitability of any information or product for the use to be contemplated is the sole responsibility of the user. The manner of that use, and whether there is any infringement of patents, is also the sole responsibility of the user.

# globally connecting you at all levels

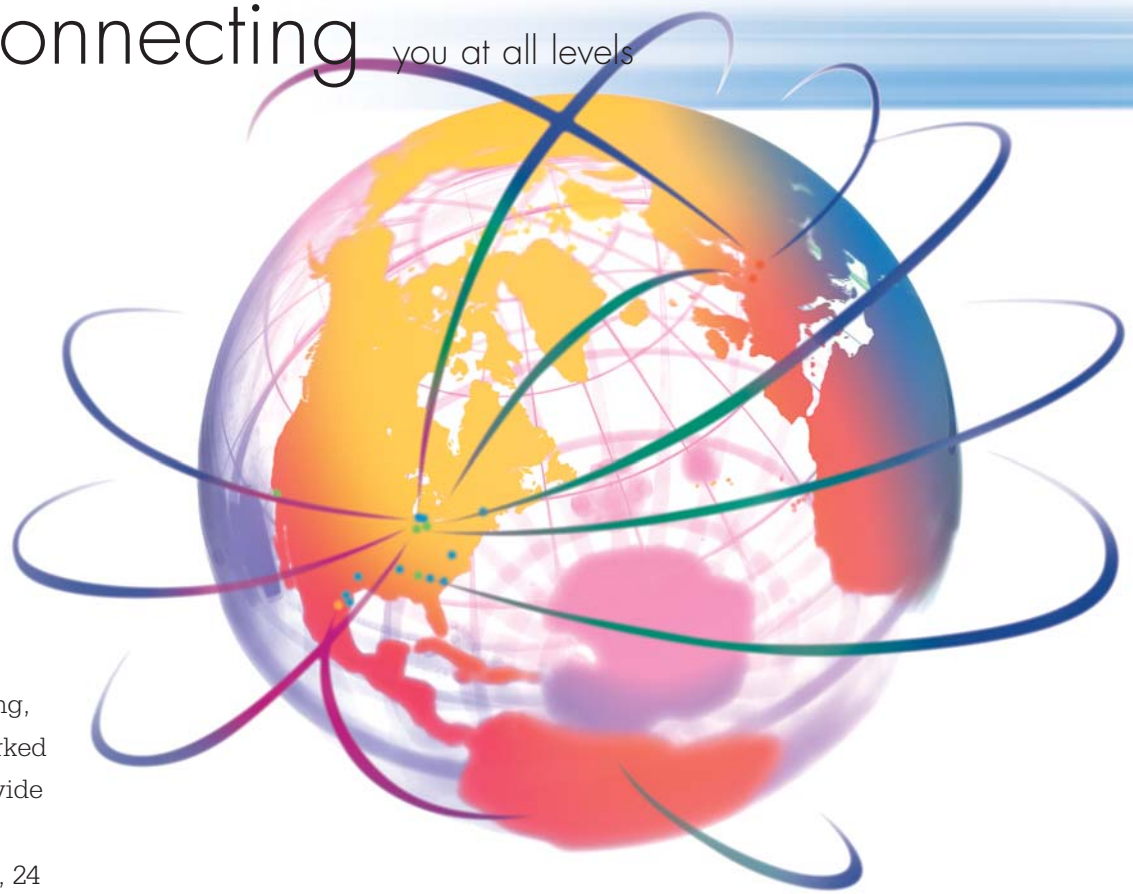

It's a new age of business, and a new way at NIBCO. From Elkhart, Indiana to Lodz, Poland, and points beyond, our company has integrated manufacturing, distribution, and networked communications to provide a seamless source of information and service, 24 hours a day, 7 days a week. But this integration hasn't happened overnight. It's been part of a long-term strategic process that has pushed us to reconsider every aspect of our business. The result? We're a vertically integrated manufacturer with the products and systems in place to deliver low cost and high quality. NIBCO® products are manufactured under a Quality Management System conforming to the current revision of ISO-9001 International Standards. We know the flow control industry is only going to get more demanding, and we are more than ready. We will continue to lead. That's what NIBCO is all about.



# FEATURING NIBCO® SYSTEMS

C-BLZM-0211

NIBCO® PEX Piping Systems • NIBCO® Press System®

## FITTINGS

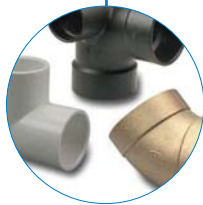

Wrot and cast copper pressure and drainage fittings • Cast copper alloy flanges  
• Wrot and cast press fittings • ABS and PVC DWV fittings • Schedule 40 PVC pressure fittings • CPVC CTS fittings • CPVC CTS-to-metal transition fittings  
• Schedule 80 PVC and CPVC systems • CPVC metric piping systems  
• CPVC BlazeMaster® fire protection fittings • Lead-Free\* fittings

BlazeMaster® is a registered trademark of The Lubrizol Corporation.  
\*Weighted average lead content ≤0.25%

## VALVES & ACTUATION

Pressure-rated bronze, iron and alloy-iron gate, globe and check valves • Pressure-rated bronze ball valves • Boiler specialty valves • Commercial and industrial butterfly valves • Circuit balancing valves • Carbon and stainless steel ball valves  
• ANSI flanged steel ball valves • Pneumatic and electric actuators and controls  
• Grooved ball and butterfly valves • High performance butterfly valves • UL/FM fire protection valves • MSS specification valves • Bronze specialty valves • Low pressure gate, globe, check and ball valves • Frostproof sillcocks • Quarter-turn supply stops • Quarter-turn low pressure valves • PVC ball valves • CPVC CTS ball valves • Just Right® recirculating valves • Bronze & Iron Y-Strainers  
• Lead-Free\* valves

\*Weighted average lead content ≤0.25%



## CHEMTROL®



Thermoplastic pipe, valves and fittings in PVC, Corzan® CPVC, polypropylene and PVDF Kynar® • Pneumatic and electric actuation systems

Corzan® is a registered trademark of The Lubrizol Corporation. • Kynar® is a registered trademark of Arkema Inc.

## eNIBCO

EDI—Electronic Data Interchange • VMI—Vendor Managed Inventory  
• NIBCO.com • NIBCOpartner.com



**NIBCO®**  
AHEAD OF THE FLOW®

**NIBCO INC.**  
**WORLD HEADQUARTERS**  
WEB: [www.nibco.com](http://www.nibco.com)

1516 MIDDLEBURY STREET  
ELKHART, IN 46516-4740  
USA

DOMESTIC CUSTOMER SERVICE  
PHONE: 800.234.0227  
FAX: 800.234.0557

TECHNICAL SERVICE  
PHONE: 888.446.4226  
FAX: 888.336.4226

INTERNATIONAL OFFICE  
PHONE: +1/574.295.3327  
FAX: +1/574.295.3455